

lobster phenom[®]

phenom & phenom two owner's manual

#D641,437



play more. win more.[®]

TO OUR CUSTOMERS

Thank you for purchasing a Lobster ball machine. Please read this owner's manual in its entirety before operating your Lobster ball machine. These instructions were written to ensure your safety and to protect the machine.

CHECK FOR DAMAGE

Inspect your machine for damage. The machine may appear undamaged externally, but internal parts could be damaged. Test all of the machines functions. Call Lobster Sports immediately if your machine is damaged at 800.526.4041.

SAVE THE ORIGINAL SHIPPING BOX

The original box and inserts should always be used if it is necessary to ship the machine back to the factory. Packaging instructions are available on our website at www.lobstersports.com.

Serial Number: _____

Purchase Date: _____

WARNING

TO AVOID INJURY:

- Keep face out of ball path - balls can shoot out from opening at any time.
- Use only for tennis practice with conventional tennis balls.
- Unplug the machine when leaving it unattended or before performing maintenance tasks.
- Always lift the machine using 2 people
- Never place body parts or objects into machine.
- Never operate with parts removed.
- Never add balls while machine is running.
- Never put wet tennis balls in machine.



7340 Fulton Avenue
North Hollywood, CA 91605
tel 800.526.4041 fax 818.764.6061

www.lobstersports.com
sales@lobstersports.com
support@lobstersports.com

MACHINE ASSEMBLY

Intended Use

This tennis ball machine is intended to be used in a dedicated tennis facility. For safety reasons, players should stand on the opposite side of the tennis net at a minimum of 35 feet away from the machine. This tennis ball machine is designed to throw tennis balls only.

Unpack and Assembly

- Your Lobster phenom™ tennis machine is shipped in two pieces; Remove both pieces from their boxes and place the lower section (base unit) upright on its wheels.
- Do not remove the wire deflectors.
- A Phillips head screwdriver is required for assembly.
- Remove the black handle from all packaging material.
- Remove the screws from the enclosed bag and separate the three types of screws. Included are:
 - **two 3" Screws;**
 - **four 2" Screws;**
 - **four Wing Screws;**
 - **four Washers**

Setup

1. Slide the black handle (A) into the mounting holes on the base unit.
2. Insert the larger 3" screws (B) into the center holes as shown to the right.
3. Insert the smaller 2" screws (C) into the first and last holes as shown to the right.
4. Using two people, lift the hopper (upper) unit onto the base (lower) unit.
5. Tilt the hopper back or sideways (left or right) to reveal the power wires within both halves.

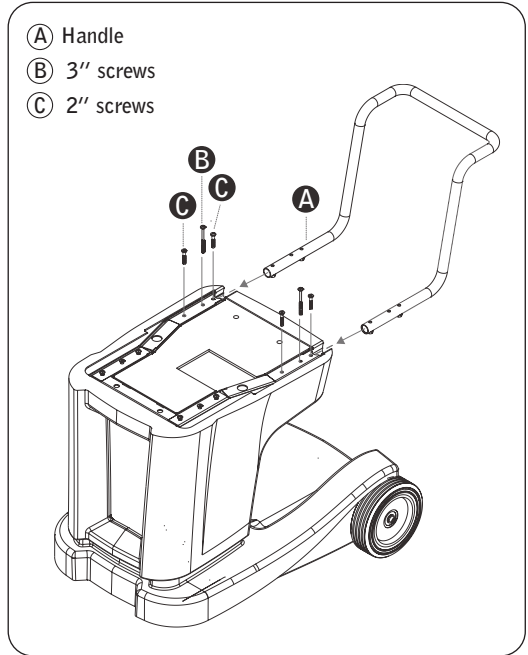

(continues on next page)

MACHINE ASSEMBLY CONTINUED

6. Locate the female wire connector at the center of the base unit (lower half) and attach it to the male wire connector in the center of the hopper unit's lower section. The wires should click and lock together easily.
7. Verify that the already connected wire assembly feeds into the cutout area of the base unit and is not being pinched where the two units meet.
8. Place the hopper into the proper location using the guides. There are 4 metal extensions on the bottom of the hopper unit that will fit into 4 holes on the top of the base unit. They will 'click' into place when properly aligned.
9. Use the provided 4 wing screws and 4 washers to secure the base unit to the hopper unit from the underside, as depicted below.

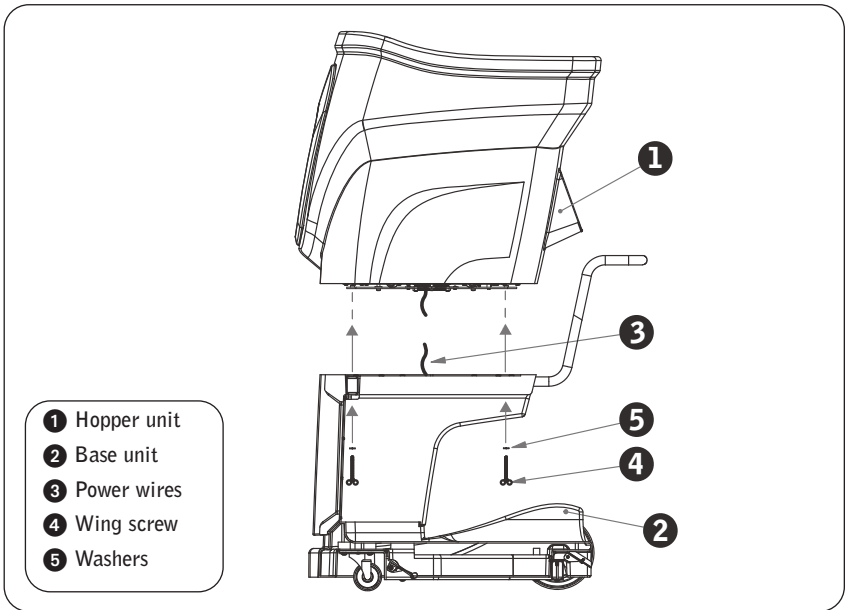

Transporting

The handle is provided to push or pull the machine into position on the court. If the machine needs to be transported to a new facility, it is recommended that the two halves be separated and secured individually.

PHENOM OPERATING INSTRUCTIONS

Your Lobster phenom™ computerized ball machine has been designed to keep the tennis ball in the full singles court. **You MUST calibrate your machine at the beginning of each play session to your court and current conditions in order to maintain accuracy. This does NOT need to be done each time you refill the hopper with balls.**





Court Placement Instructions

- Start by centering the machine on court center mark, directly behind the baseline.
- **Only use one standard, outdoor extension cord, 14-16 gauge. Using cords longer than 100 feet or more than one cord may result in reduced performance.**

Brake Set & Release

- **BEFORE USE:** Push on the brake pad with your foot until you hear or feel the brake engage. Confirm that the front wheels remain positioned over the baseline, at the court's center mark.
- **AFTER USE:** To disengage the brake, step on the red base with your foot, pushing forward with your body weight.





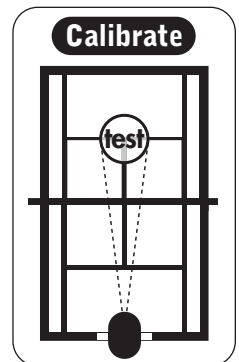
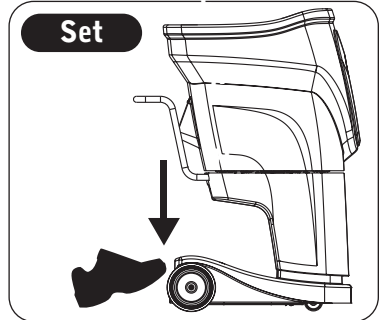

Calibration

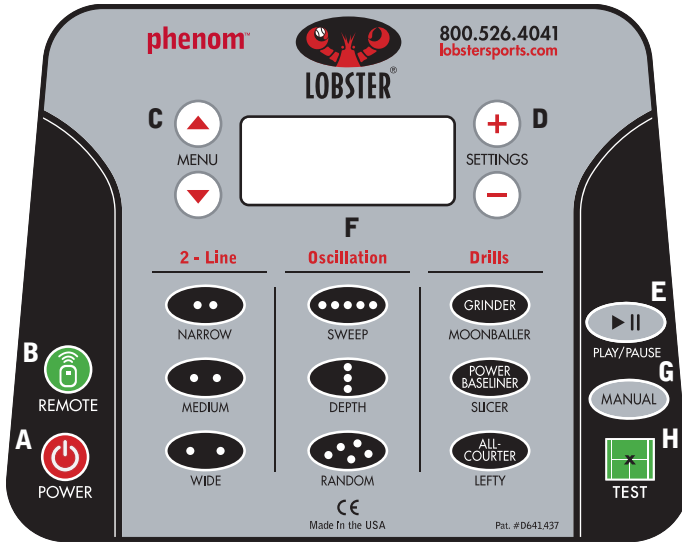
- Power on  the machine and allow it to go through a self test.
- Push the  TEST button. One tennis ball should be thrown over the net to land within a 2 foot area of the opposite side of the court where the service and center lines converge, just as depicted by the TEST button and the diagram below.
 - If the test ball lands outside of the 2 foot radius, long or short use the  and  SETTINGS buttons to adjust the distance in .5 foot increments. If the ball should fall outside of the area left or right, move the back of the machine slightly to the left or right, as needed. Retest and make adjustments as necessary.
- Once the test is complete, press the manual button or one of the nine preset buttons in the center of the control panel to choose mode of play, then press the play button.



PHENOM CONTROL PANEL







- A.**  **Power Button** – Push and hold the POWER button to turn the machine on. Both the horizontal and vertical motors will perform functional checks to calibrate the machine when it is turned on or off.
- B.**  **Remote** – Push this button to turn on/off the remote control receiver.
- C.**  **Menu Buttons** – Use to scroll through the menu options to be selected and adjusted. A cursor on the LCD will highlight the current selection.
- D.**  **Settings** – Use to adjust a highlighted option on LCD screen.
- E.**  **Play/Pause** – Use to begin the play of a selected function and/or to pause the feed.
- F. Presets** The nine buttons in the center of the control panel are used to select the play mode. Menu and Settings buttons are used to select and adjust shot parameters. After the shot parameters are satisfactory, press play to start.
- G.**  **Manual** – Machine will continuously throw a certain shot to a specific location.
- H.**  **Test** – Used to align your machine for proper ball placement on the court.





PHENOM OPERATING INSTRUCTIONS CONTINUED



Presets

Main preset options are selected by pressing one of the nine buttons in the center of the control panel. The machine will automatically pause until you are satisfied with the settings. Press the play/pause button to begin play. Use  /  menu buttons to scroll through locations and shot parameters. Use  /  buttons to increase or decrease value of the selected menu option. **PLEASE NOTE: To keep all shots in the court, some options are not available in conjunction with each other.**

2-LINE

-  **Narrow** – Practice forehand and backhand strokes at the center of the court.
-  **Medium** – Practice forehand and backhand strokes midway between center court and sideline.
-  **Wide** – Practice forehand and backhand strokes at the sidelines.
 - Speed – Choose from 40 to 80 MPH in 5 mph increments.
 - Spin – Increase and decrease top and back spin up to three levels.
 - Depth – Deep, Mid, Short, or Random settings.
 - Feed – Adjust between 2-9 second intervals, or scroll down to random.

OSCILLATION: Throws balls the entire court - left, right, short, & deep using a fixed speed.

-  **Sweep** – Throw balls randomly across the width of the court. Shot parameters are adjustable and include:
 - Depth – Deep, Mid, Short, or Random settings.
 - Speed – Choose from 40 to 80 MPH in 5 mph increments.
 - Spin – Increase and decrease top and back spin up to three levels.
 - Feed – Adjust between 2-9 second intervals, or scroll down to random.
-  **Depth** – balls thrown randomly from short to deep. Shot parameters include:
 - Position – At the top of the LCD, choose balls to be thrown the Left, Center, or Right side of the court.
 - Speed – Choose from 40 to 80 MPH in 5 mph increments.
 - Spin – Increase and decrease top and back spin up to three levels.
 - Feed – Adjust between 2-9 second intervals, or scroll down to random.
-  **Random** – Machine randomly throw balls using variations of speed, spin and trajectory.
 - Feed – Adjust between 2-9 second intervals, or scroll down to random.

PHENOM OPERATING INSTRUCTIONS - DRILLS

Drills

Each of the six custom designed court drills consists of six sequential shots in a designated pattern combining court location, ball speed, and spin. To adjust the difficulty, the feed rate can be set to a fixed 2 - 9 seconds or a random setting that will constantly change the feed rate. Use the (+) / (-) SETTINGS buttons. Low feed settings will have a short pause between cycles.

- GRINDER** utilizes the full back court with different types of spin.
- MOON BALLER** Press GRINDER twice to select MOONBALLER drill, which utilizes a high arc over the net with moderate to heavy top spin.
- POWER BASELINER** utilizes the full back court with little spin and more ball speed.
- SLICER** Press POWER BASELINER twice to select the SLICER drill with backspin or underspin that utilizes a low arc over the net.
- ALL COURTER** utilizes both the front and back court with some top spin and less ball speed.
- LEFTY** Press ALL COURTER twice to select LEFTY, which simulates strong forehand groundstrokes and strong backhand volleys.

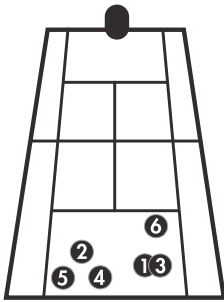

Grinder

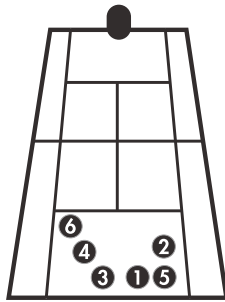

Power Baseline

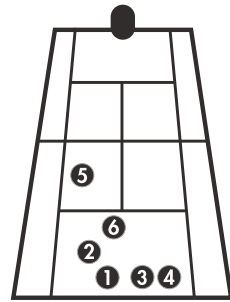

All-Courter

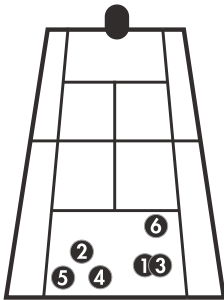

Moon Baller

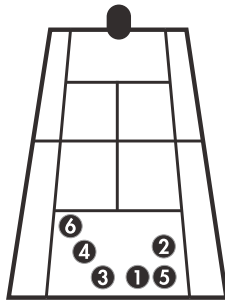



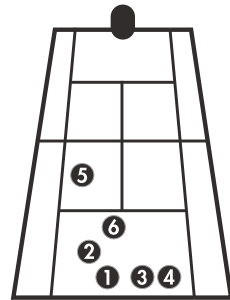

Slicer



Lefty

PHENOM OPERATING INSTRUCTIONS CONTINUED

Manual

Press the MANUAL button to practice one particular shot repetitively. The machine will pause while you make your adjustments. Use  /  menu buttons to select location and shot parameters. Use  /  SETTINGS buttons to increase or decrease value of the selected menu option.

- Speed – Choose from 35 to 80 MPH in 5 mph increments.
- Elev – Adjust elevation between level 2 and 80 in 1 level increments to change the height of the shot thrown on the court.
- Spin – Increase and decrease top and back spin up to three levels.
- Angle – Choose position along baseline. 0 is center court with positive numbers moving to the right and negative numbers moving to the left.
- Feed – Adjust between 2 - 9 second intervals, or scroll down to random setting.

When you are satisfied with your adjusted settings press the  Play/Pause button to start your session. **PLEASE NOTE: To keep all shots in the court, some options are not available in conjunction with each other.**

PHENOM TWO CONTROL PANEL

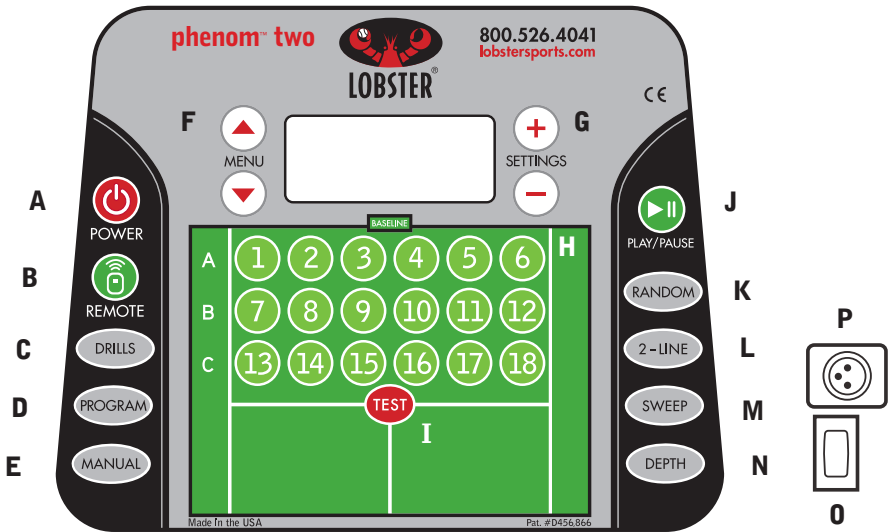

- A. **Power** – Push and hold the POWER button to turn the machine on. Battery level is shown at startup. Both the horizontal and vertical motors will perform functional checks to calibrate the machine when it is turned on or off.
- B. **Remote** – Push this button to turn on/off the remote control receiver.
- C. **Drills** – 12 different pre-programmed sequences that mimic opponent play.
- D. **Program** – Press to create customized drills.
- E. **Manual** – Machine will continuously throw a certain shot to a specific location.
- F. **Menu Buttons** – Used to scroll through the menu options to be selected and adjusted. A cursor on the LCD will highlight the current selection.
- G. **Settings** – Used to adjust a highlighted option on LCD screen.
- H. **1-18 Numbered Buttons** – Used to select desired position for ball to land in program mode. (More detailed information can be found in the program section.)
- I. **Test** – Used to align your machine for proper ball placement on the court.
- J. **Play/Pause** – Press to play and pause the machine.
- K. **Random** – Random throws using variations of speed, spin and trajectory.
- L. **2-Line** – Alternating forehand and backhand shots, with varying degrees of difficulty.
- M. **Sweep** – Throw balls randomly across the WIDTH (left-right) of the court.
- N. **Depth** – Throws balls randomly the LENGTH of court, from short to deep in one row.
- O. **Main Power Switch** – Main power cut off. (This switch is located on the left side of the metal box directly below the control panel).
- P. **Charger Connector** – Used to charge your battery.



PHENOM TWO OPERATING INSTRUCTIONS - DRILLS

Drills

The drills button allows for pre-programmed training exercises. Each of the six custom designed court drills consists of six sequential shots in a designated pattern combining court location, ball speed and spin. To adjust the difficulty, the feed rate can be set to a fixed 2 - 9 seconds or a random setting that will constantly change the feed rate. Use the ⊕/⊖ buttons to adjust this rate. Low feed settings will pause between cycles.

EXERCISE DRILLS

Approach – Six ball drill emphasizing the approach from behind the baseline into the front court with balance and speed.

Attack/Defend – Six ball drill designed to teach a player to move in all directions from the baseline.

Forehand Plus – Six ball drill challenging the player to maintain dominant court position by using their forehand for every shot.

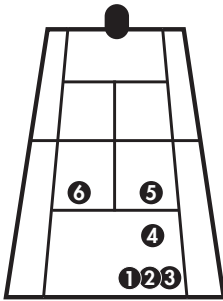

Approach

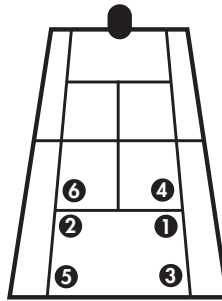

Attack / Defend

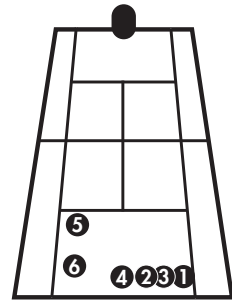

Forehand Plus

Beginner – Six ball drill to help beginners improve and build confidence.

Intermediate – Six ball drill that will help intermediates improve their court coverage and execute a variety of shots.

Advanced – Six ball drill for advanced players to develop higher shot tolerance and learn to quickly identify 'opportunity' balls that can be attacked.

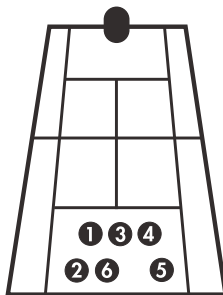

Beginner

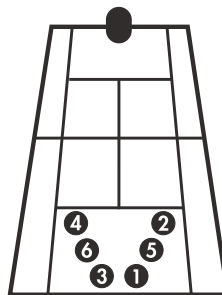

Intermediate

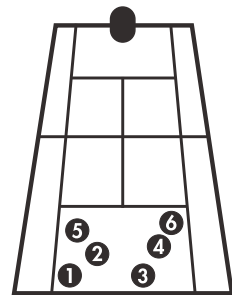

Advanced

PHENOM TWO OPERATING INSTRUCTIONS - DRILLS

Drills

Each of the six custom designed court drills consists of six sequential shots in a designated pattern combining court location, ball speed, and spin. To adjust the difficulty, the feed rate can be set to a fixed 2 - 9 seconds or a random setting that will constantly change the feed rate. Use the (+) / (-) SETTINGS buttons. Low feed settings will have a short pause between cycles.

- GRINDER** utilizes the full back court with different types of spin.
- MOON BALLER** Press GRINDER twice to select MOONBALLER drill, which utilizes a high arc over the net with moderate to heavy top spin.
- POWER BASELINER** utilizes the full back court with little spin and more ball speed.
- SLICER** Press POWER BASELINER twice to select the SLICER drill with backspin or underspin that utilizes a low arc over the net.
- ALL COURTER** utilizes both the front and back court with some top spin and less ball speed.
- LEFTY** Press ALL COURTER twice to select LEFTY, which simulates strong forehand groundstrokes and strong backhand volleys.

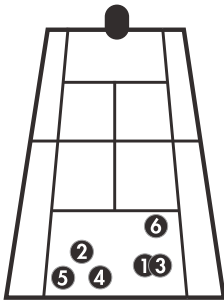

Grinder

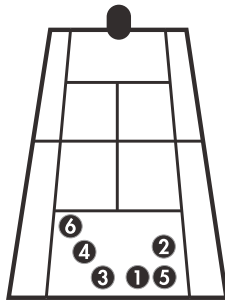

Power Baseline

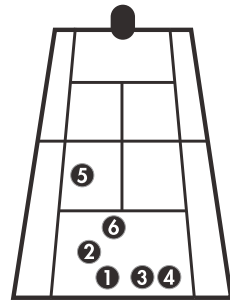

All-Courter

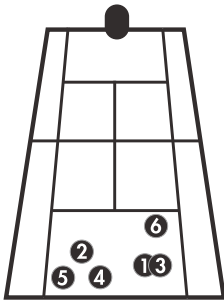

Moon Baller

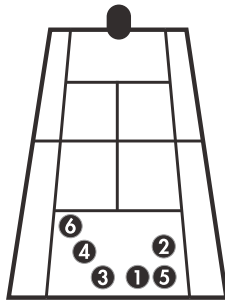

Slicer

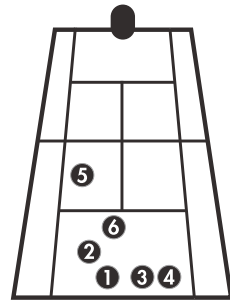

Lefty

PHENOM TWO OPERATING INSTRUCTIONS CONTINUED

Manual MANUAL

Press the MANUAL button to practice one particular shot repetitively. The machine will pause while you make your adjustments. Use \blacktriangle / \blacktriangledown Menu buttons to select location and shot parameters. Use \oplus / \ominus settings buttons to increase or decrease value of the selected menu option.

- Speed – Choose from 35 to 80 MPH in 5 mph increments.
- Elev – Adjust elevation between level 2 and 80 in 1 level increments to change the height of the shot thrown on the court.
- Spin – Increase and decrease top & back spin up to 3 levels.
- Angle – Choose position along baseline. 0 is center court with positive numbers moving to the right and negative numbers moving to the left.
- Feed – Adjust between 2-9 second intervals, or scroll down to random.

When you are satisfied with your adjusted settings press the \blacktriangleright Play/Pause button to start your session. **PLEASE NOTE: To keep all shots in the court, some options are not available in conjunction with each other.**

Random RANDOM

Randomly throw balls on the court using variations of speed, spin and trajectory.

- Feed – Adjust between 2-9 second intervals, or scroll down to random.

2-line Function 2-LINE

- Speed – Choose from 40 to 80 MPH in 5 mph increments.
- Spin – Increase and decrease top and back spin up to three levels.
- Depth – Row A (Deep), Row B (Mid), Row C (Short), Random (depth will constantly change).
- Feed – Adjust between 2-9 second intervals, or scroll down to random.

Sweep SWEEP

Throw balls randomly across the width of the court. Shot parameters remain at the same setting during play and include:

- Depth – Row A (Deep), Row B (Mid), Row C (Short), Random (depth will constantly change).
- Speed – Choose from 40 to 80 MPH in 5 mph increments.
- Spin – Increase and decrease top & back spin up to three levels.
- Feed – Adjust between 2-9 second intervals, or scroll down to random.

Depth DEPTH

Throw balls randomly from short to deep. Shot parameters remain at the same setting during play and include:

- Position – At the top of the LCD, choose column you wish the balls to land in. Column number matches buttons in the top row of your control panel.
- Speed – Choose from 40 to 80 MPH in 5 mph increments.
- Spin – Increase & decrease top & back spin up to 3 levels. (depending on speed)
- Feed – Adjust between 2-9 second intervals, or scroll down to random.

PHENOM TWO OPERATING INSTRUCTIONS CONTINUED

Program











The program function allows you to create your own drills, up to six personal programs, and set up your own training exercises. You may create sequences of shots with anywhere from 1 to 6 balls that will cycle. This allows for many more combinations that will always give you new challenges. There are limitations to what the machine can do...please read this carefully.

- The serving wheels can speed up faster than they can slow down. Fast shots followed by slow shots or drastic changes in spin will produce shots out the back of the court if used with fast feed rates. If you wish to use faster feed rates, keep your changes in speed and spin incremental. A good guide is not to change the speed more than your feed rate times 5 in miles per hour (treat each level of spin as 5 MPH).

As an example : A feed rate of 4 sec will let you have up to 20 mph of change or 4 levels of spin.

- Certain combinations of speed and spin will not stay within the court. If a setting will not produce a viable shot, the display will blink to tell you that the shot is not possible and remain at the previous setting.
- When you have filled up the 6th shot in a program, selecting next will automatically take you to the overall program screen.

To Create Your First Personal Program

1. Press the  button.
2. The screen will prompt you to select a location for your first shot. Press any of the 1 to 18       buttons to advance to the shot parameters screen.
3. The machine will be programmed to throw one ball to the location selected. You may now adjust the shot parameters for this shot:
 - Speed – Chose from 40 to 80 MPH in 5 mph increments.
 - Spin – Increase and decrease top and back spin up to three levels.
 - Feed – Adjust between 2-9 second intervals, or scroll down to random setting.
4. When the shot is satisfactory, use the menu buttons  /  to highlight the "Next + Back -" line. Press  to choose the location and shot parameters for the next shot in your drill or  to return to overall program screen.

SHOT LOCATION SCREEN

P#1 SHOT#1 LOC ?
Press a location
To prgrm shot, or
Press - to erase

SHOT PARAMETERS SCREEN

P#1 SHOT#1 LOC?*
SPEED: 70 MPH
Spin :0 FEED: 4
Next + Back -

*will display your selected location

PHENOM TWO OPERATING INSTRUCTIONS CONTINUED

5. Selecting and running a drill can be done from the Overall Program Screen:

- The top line displays your program number.
You can change the program number from 1-6 by highlighting the top line with the menu buttons \uparrow / \downarrow and adjusting the number with \oplus / \ominus settings buttons.
- Line 2 will show you the court location of each ball thrown. One number for each ball.
- Line 3 allows you to edit or view the settings of an existing shot in the program.
- Pressing \rightarrow at any time on this screen will run the program.

OVERALL PROGRAM SCREEN

```
PROGRAM # : 1
LOCS 3 4 5 1 6 3
SHOT: 2  EDIT : NO
PUSH PLAY TO RUN
```

Editing An Existing Program

Once you have created a program you may want to adjust or completely redesign any aspects of the program.

1. If you are not already in the program function, press the PROGRAM button to display the overall Program screen.
2. First use the \oplus / \ominus settings buttons to select the program you wish to adjust.
3. Next use the menu buttons \uparrow / \downarrow to highlight SHOT then adjust the number to reflect which shot in the sequence you wish to adjust (1st, 2nd, 5th...)
4. Highlight edit and press the \oplus button to change to a yes. This will take you to the Select Location Screen.
5. The current location of this shot is now displayed in the upper right corner. If you are satisfied with the location, press the same number to select it again and you will advance to the shot parameters screen which will display your current settings.
6. If you chose another location, the defaults will reset.
7. You can remove the shot from the drill by pressing the \ominus button. This will return you to the overall program screen and the drill will run with one less shot.

OVERALL PROGRAM SCREEN

```
PROGRAM # : 1
LOCS 3 4 5 1 6 3
SHOT: 2  EDIT : NO
PUSH PLAY TO RUN
```

SHOT LOCATION SCREEN

```
P#1 SHOT#2 LOC 4
Press a location
To prgrm shot, or
Press - to erase
```

OPERATING INSTRUCTIONS - REMOTE CONTROL (OPTIONAL)

Remote Control

The remote consists of fifteen buttons and allows you to operate many of the functions on your ball machine from a distance.

- Press the  REMOTE button located on the control panel to activate remote. When LED is lit the machine will accept commands from your remote controller.

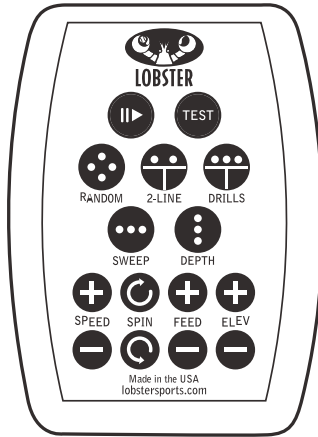

- **PLAY/PAUSE** button will start and stop the machine at any time.
- **TEST** - Allows you to calibrate your machine.
- **RANDOM** - Press button to activate the fully random function.
- **2-LINE** - Press button multiple times to scroll through the narrow, medium, wide and random settings for the 2-line functions.
- **DRILLS** - Press button multiple times to scroll through pre-programmed drills.
- **SWEEP** - Press button multiple times to scroll through the short, mid, deep and random settings for the sweep function.
- **DEPTH** - Press button multiple times to scroll through left to right position settings for the depth function.
- Lower 8 black buttons - Use to change shot parameters on the fly for the presets.
 - **Speed** – Adjust the ball speed for 2-line, sweep, depth, and manual presets.
 - **Spin** – Adjust the top or bottom spin for 2-line, sweep, depth, and manual presets.
 - **Feed** – Adjust the ball interval for all settings.
 - **Elevation** – Adjust the elevation for 2-line, manual, and test function.

Using the remote while a drill is running will cause the next shots parameters to change temporarily. Doing so may cause shots to land in unplayable areas.

TROUBLESHOOTING

Machine Doesn't Power On

- Did you connect the wires from the base unit to the hopper unit when you assembled it?
- Has the reset switch on the machine's power plate been tripped?
- Is your extension cord over 100 feet?
- Are you using multiple extension cords?
- Does the electrical socket run any other devices?
- Did you check for balls stuck behind the server wheels?

Machine Error

The electronics are programmed to help the user diagnose his/her machine.

Error messages will appear on the LCD screen when the machine is turned on.

If there is no obvious problem, unplug the machine, plug the machine back in and turn the machine's power button on again. If the error message continues, call Lobster Customer Service at 800.526.4041.

MAINTENANCE

Inclement Weather

Never store the machine outside. Exposure to rain and snow will shorten the life of the machine. While the custom cover for the machine will protect it from light weather conditions, prolonged exposure to humidity and extreme temperature can affect the electronics and mechanics even if covered.

Storage

Store the machine unplugged in a clean, dry location. Extreme temperatures and conditions can affect the machine's electronic board and power supply. Exposure to rain and snow will damage the electronics.

Cleaning

Unplug the machine when cleaning it. The outside of the machine may be wiped down with a mild detergent. The inside of the machine may be vacuumed to remove tennis ball fuzz. The Lobster storage cover is an ideal way to protect your machine from the elements.

Ball Consistency

The consistency of ball throws is dependent on the consistency of the tennis balls you use. Consistent balls will produce consistent ball throws. A mixture of new and old balls will produce inconsistent ball throws. Pressureless balls are recommended for use with a ball machine. For more information, call Lobster at 800.526.4041.

CUSTOMER SERVICE

Since 1970, Lobster Sports has been dedicated to providing outstanding customer service. To this end, we invite our customers to contact our Customer Service Department at **800.526.4041** anytime between 8:00am - 4:30pm PST, Monday through Friday. After hours, please leave a voice message or email us at support@lobstersports.com

Shipping Damage

If an order arrives with shipping damages, contact Customer Service to coordinate sending a replacement. If a replacement part can resolve the issue, Lobster will ship the part immediately. If not, a damage call tag will be issued. Upon pick up of the damaged machine, the customer must call in the pick-up tracking number and a replacement will be shipped immediately.

Mis-Shipments

Lobster Sports maintains the highest manufacturing and shipping quality standards and strives for 100% accuracy. However, in the event an order is not correct please contact Customer Service to rectify the situation.

LIMITED WARRANTY

Lobster Sports warrants that each Lobster Sports ball machine purchased will be free from defects in material and workmanship for 2 years from the date of purchase except for the battery and server wheels which are warranted for 6 months. Demonstration models and reconditioned machines have a 1 year warranty. Said warranty to be determined by Lobster Sports at time of purchase. Any part of ball machine which proves to be defective in material or workmanship within the 2 year warranty period will be repaired or replaced at Lobster Sports' option with a new or functionally operative part. Warranty extends only to the original customer and may be enforced only by such person.

This warranty does **not** cover the following conditions: A) Damage resulting from misuse, neglect, alteration, accidents, tampering, abuse, fire, war, insurrection, civil disorder, flood, acts of God or any other casualty; B) Failure of Customer to properly follow operating instructions provided by Lobster Sports at time of delivery; and C) Damage caused by use on circuits or voltages other than indicated on the applicable nameplate.

This limited warranty is in lieu of all other express warranties. Any implied warranties of merchantability and fitness for a particular purpose shall coincide in duration with the 2 year limited warranty. The exclusive remedy of the Customer hereunder shall be repair or replacement as stated above. Under no circumstances shall Lobster Sports be liable to the Customer or any other person for incidental or consequential damages of any nature, including, without limitation, damage for personal injury or damages to property; and however occasioned, whether alleged as resulting from breach of warranty by Lobster Sports, the negligence of Lobster Sports.

No agent, employee or representative of Lobster Sports or any other person is authorized to modify this warranty in any respect. This warranty gives you specific legal rights and you may also have other rights, which vary, from state to state.

This limited warranty is void unless Customer completes and returns the attached **warranty response form** to Lobster Sports within 30 days of receipt of the ball machine.



WARRANTY REGISTRATION - To validate warranty, fill out card and send back via mail or email to warranty@lobstersports.com. If you bought from a authorized dealer, please also include proof of purchase. (*Required Fields)

Machine Serial Number* _____

Name* _____ Email* _____

Mailing Address* _____ City* _____ State* _____ Zip* _____

Phone* _____

Purchase Date* _____ Where Purchased* _____

How did you learn about Lobster? (circle) Lobster Website Google Yahoo MSN Pro Friend Dealer
Dealer Website _____ Tennis Magazine Tennis Week Magazine Other Magazine/Search Engine _____

What attracted you to this product? (circle) Quality Design Price Reputation Previous Customer Portability Better Features

Income (circle) \$40-60K \$60-80K \$80-\$100K \$100-\$120K \$120-140K \$140-\$160K \$160-\$180K \$180-200K \$200K+

Age (circle) 15-25 25-35 35-45 45-55 55-65 65-75 75-85 85+ **Occupation** _____

OPTIONAL EXTENDED WARRANTY** Please send in a separate envelope within 60 days of purchase.

Please select from the following:		Credit Card # _____	Expiration Date _____
<input type="checkbox"/> 1 Year	\$199	Verification Code (last 3 digits in signature bar) _____	Select (circle) Visa Mastercard Discover Card
<input type="checkbox"/> 2 Years	\$299	Authorization Signature _____	
<input type="checkbox"/> 3 Years	\$399		

Lobster Sports warrants each Lobster phenom™ machine purchased will be free from DEFECTS IN MATERIAL AND WORKMANSHIP for the extended period specified above past the normal 2 year limited warranty. The extended warranty period will run consecutively from the warranty period determined at time of purchase. **It does not cover parts worn under normal use**, specifically, the server wheels and the included, external power cord.
**Extended warranties only apply to machines located in the United States.

place
stamp
here



LOBSTER[®]

7340 Fulton Avenue
North Hollywood, CA 91605